

# Data Sheet



Article number: 021500700089

Description: Sealing Clamp S 89 W5

## Measures

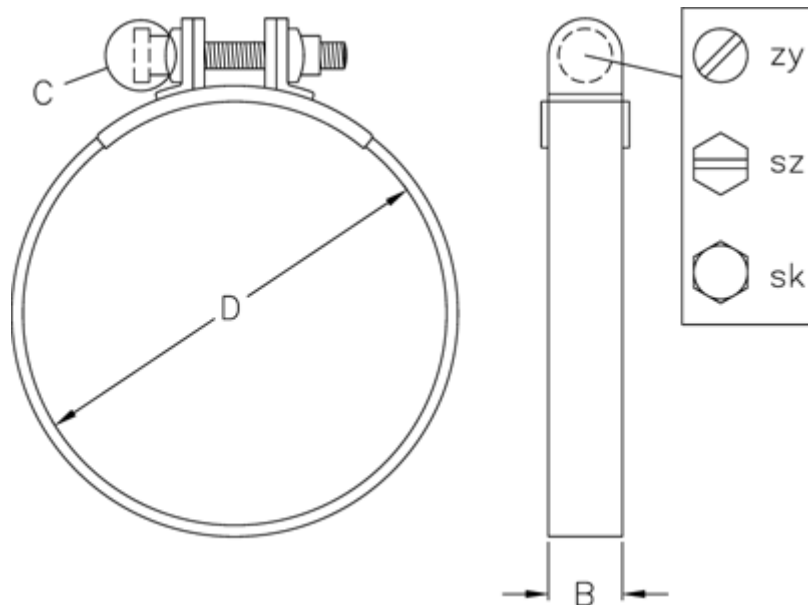

C (screw type) = SZ

Diameter D = 89

Width B = 20